

CS1
OUTER FRAME/MULLION

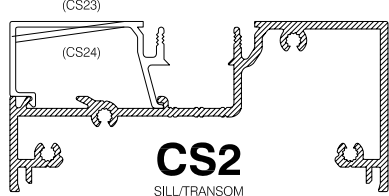

CS2
SILL/TRANSOM

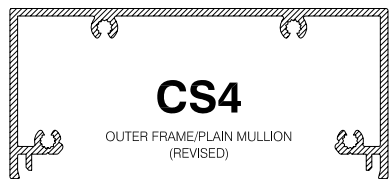

CS4
OUTER FRAME/PLAIN MULLION
(REVISED)

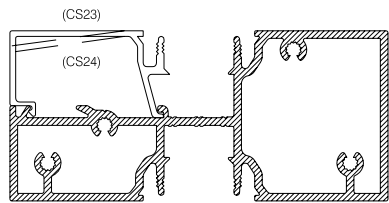

CS5
SILL/TRANSOM (BOX)
(AMENDED PORTS)

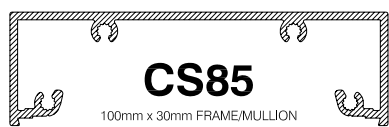

CS85
100mm x 30mm FRAME/MULLION



CS668
HEAVY DUTY ALTERNATIVE TO CS8
INFILL PLATE - PLAIN



CS8
INFILL PLATE - PLAIN

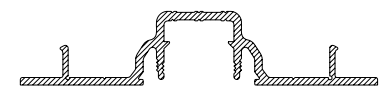

CS9
INFILL PLATE - POCKETED



CS90
FINGER GUARD INSERT



CS369
INFILL PLATE (DOUBLE BEAD)

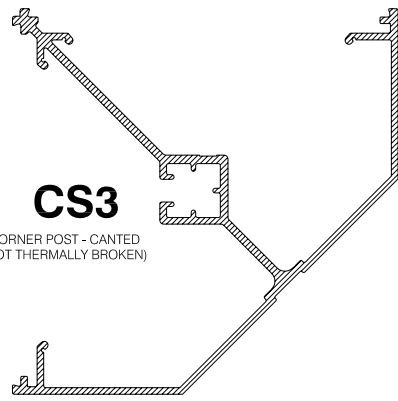

CS3
CORNER POST - CANTED
(NOT THERMALLY BROKEN)

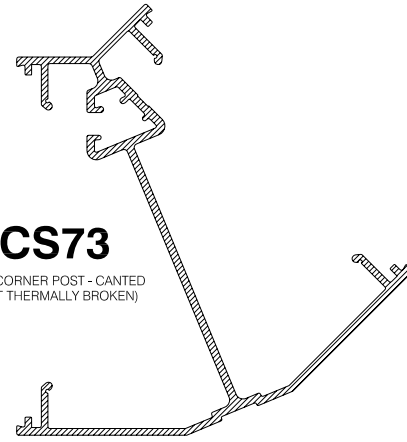

CS73
135° CORNER POST - CANTED
(NOT THERMALLY BROKEN)

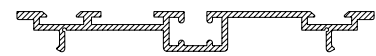

CS308
JAMB FIXING BACK PLATE

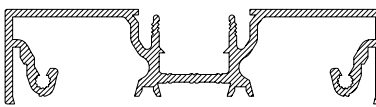

CS10
EXPANSION MULLION/OUTER FRAME



CS12
100mm x 45mm RETURN POST

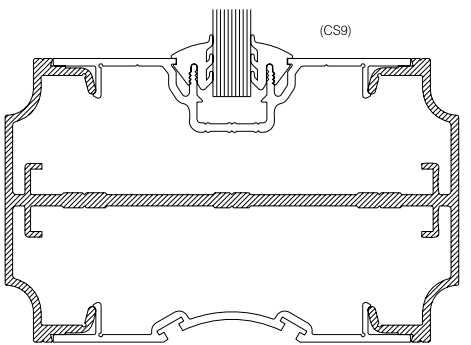

CS71
DOOR FRAME (FINGER GUARD)

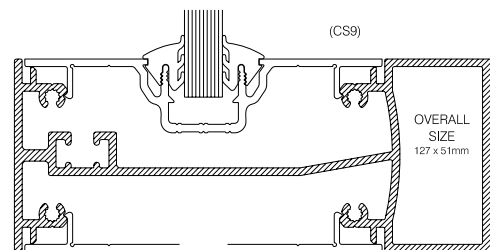

CS148
HIGH SPAN MULLION
(NOT THERMALLY BROKEN)

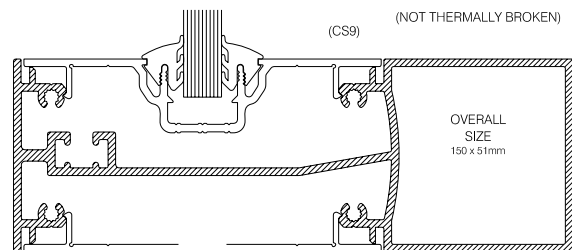

CS178
HIGH SPAN MULLION
(NOT THERMALLY BROKEN)

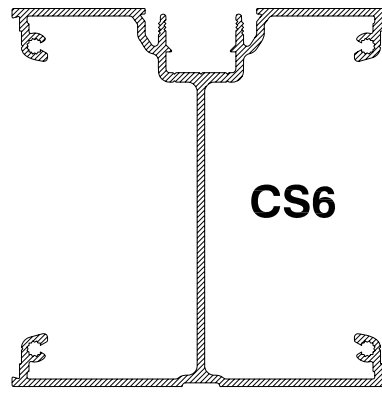

CS6
CORNER POST - SQUARE

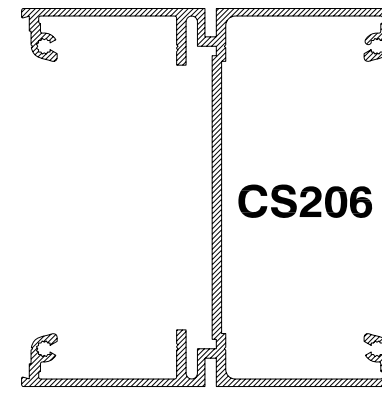

CS206
100mm x 100mm FRAME MULLION

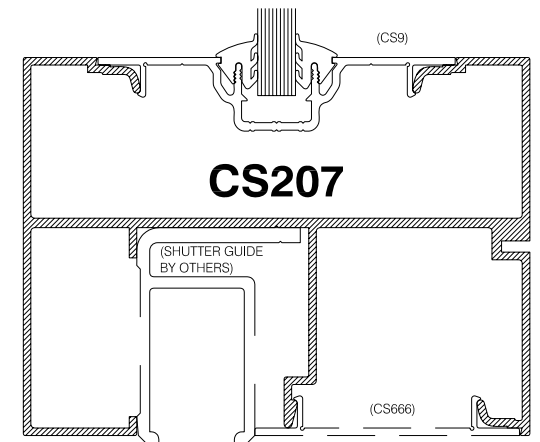

CS207
100mm x 134mm FRAME MULLION

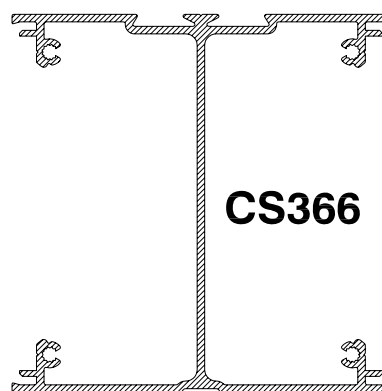

CS366
100 x 100 CORNER POST
(DOUBLE BEADED)

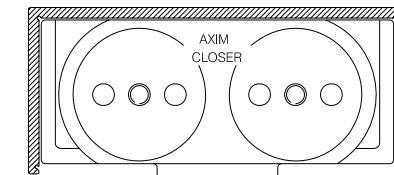

CS13
100mm x 45mm HEADER BAR

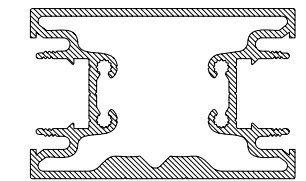

CS103
CILL/TRANSOM AUTO BEAM

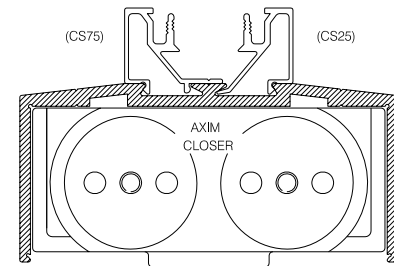

CS163
HEADER BAR DOVETAILED



CS23
GLAZING BEAD
(SQUARE)

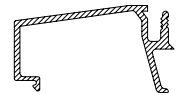

CS24
GLAZING BEAD
(WEATHERED)

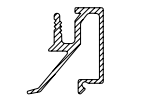

CS25
GLAZING BEAD
(SQUARE)

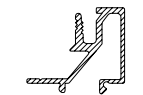

CS75
SECURITY BEAD
(SQUARE)



CS666
INFILL PLATE

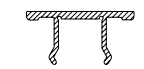

CS31
POCKET FILLER

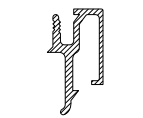

CS96
GLAZING POCKET
EXTENSION



CS68
UNIVERSAL HEADER BAR PLATE

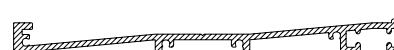

CS72
DRAINAGE TRAY



CS99
35mm SECTION EXTENSION

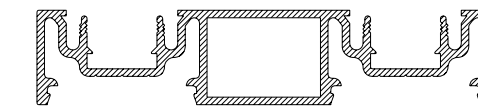

CS104
DOUBLE POCKET OUTER FRAME

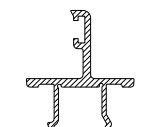

CS32
HINGE DOOR STOP (WOOLPILE)

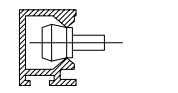

CS30
BEAD/DRAUGHT STRIP
FX047SLF PROFILE RIVET



GK89 I.D. COLOUR STRIP = GASKET 4mm GLASS



GK70 I.D. COLOUR STRIP = GASKET 6mm GLASS



GK71 I.D. COLOUR STRIP = GASKET 10mm GLASS



GK72 I.D. COLOUR STRIP = GASKET 12mm GLASS



GK88 I.D. COLOUR STRIP = GASKET 13.5mm GLASS

FOR GLASS/BEAD AND GASKET CONFIGURATIONS
SEE GLAZING OPTION (A4 GREEN BORDERED) SHEETS.

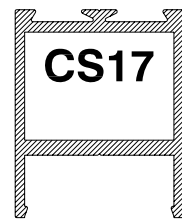

CS17

55mm SASH RAIL

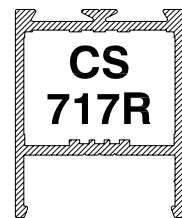

CS 717R

55mm SASH RAIL
REVISED (ECONOMY)

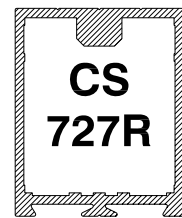

CS 727R

55mm SASH RAIL
(REVISED)

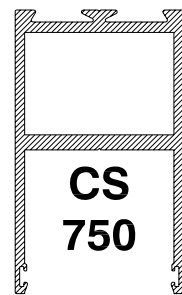

CS 750

75mm SASH RAIL



CS 740R

75mm SASH RAIL
REVISED (ECONOMY)

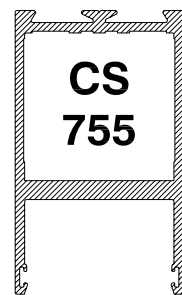

CS 755

75mm DOOR/SASH RAIL



CS721

10mm SASH/TRANSOM



CS21

10mm BEAD CARRIER

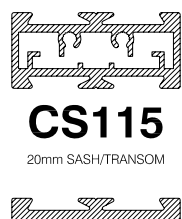

CS115

20mm SASH/TRANSOM

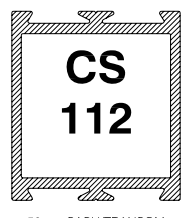

CS 112

50mm SASH/TRANSOM

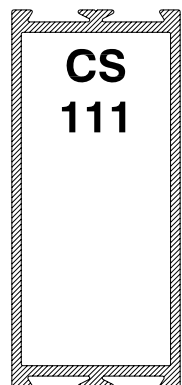

CS 111

100mm SASH/TRANSOM

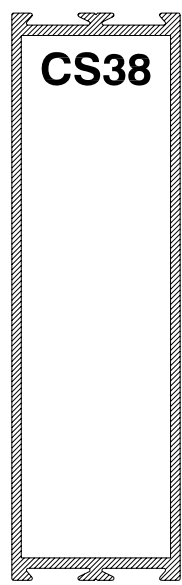

CS38

150mm SASH/TRANSOM

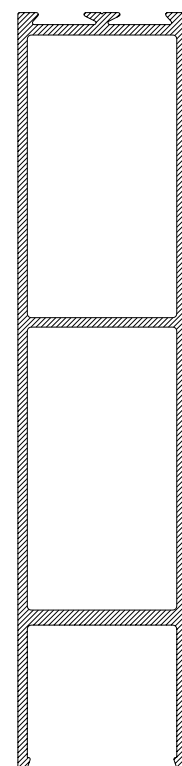

CS156

200mm SASH RAIL

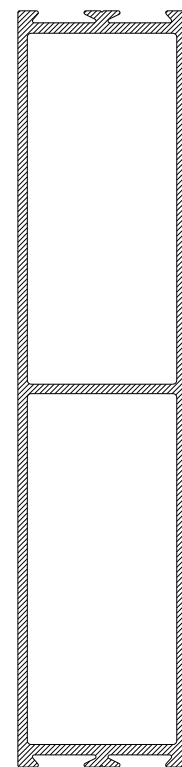

CS157

200mm SASH/TRANSOM

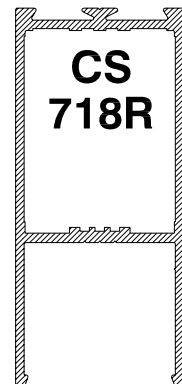

CS 718R

DOOR/SASH RAIL
REVISED (ECONOMY)

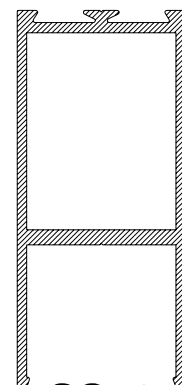

CS18

100mm SASH RAIL

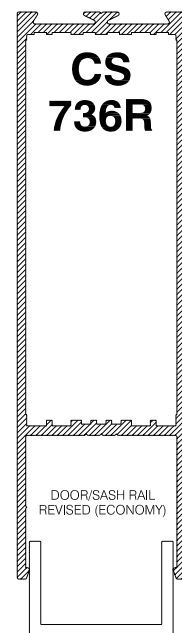

CS 736R

DOOR/SASH RAIL
REVISED (ECONOMY)

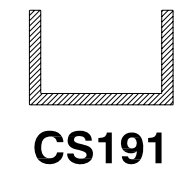

CS191

38 x 25mm x 4 MTS CHANNEL

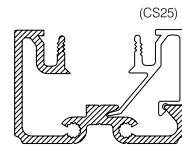

CS28

FIXED SASH CLEAT

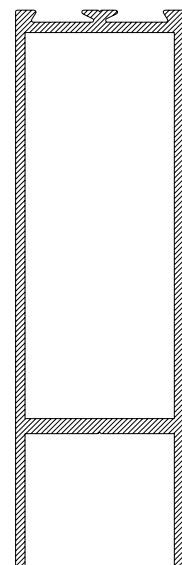

CS36

150mm SASH RAIL
(ALSO ECONOMY CS736)

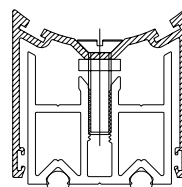

CS790

ADJUSTABLE FINGER GUARD

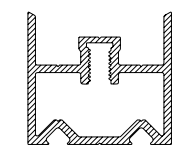

CS791

ADJUSTABLE FINGER GUARD
FIXING CHANNEL
(NEW DESIGN)

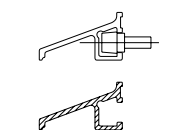

CS583

WINDOW DRIP
FX048SLF (RIVET)

(CS25)

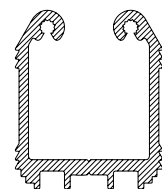

CS735

DOOR SASH, SCREW
TIE-ROD CLEAT

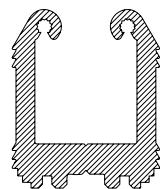

CS35R

DOOR/SASH SCREW CLEAT - DOOR
(BAR LENGTH ONLY AVAILABLE)

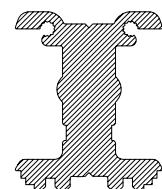

CS34

DOOR/SASH CLEAT

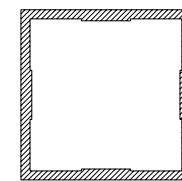

CS48

45mm x 45mm
STD BOX

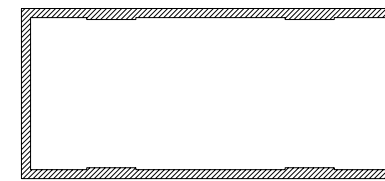

CS49

100mm x 45mm STD BOX

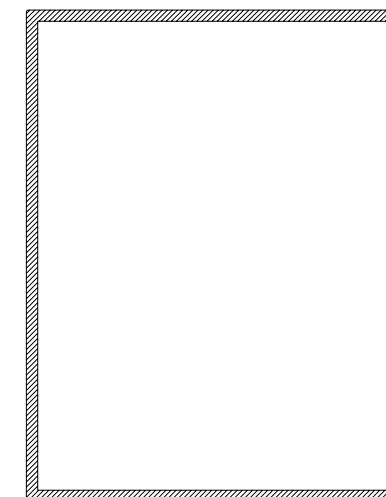

CS208

100mm x 130mm BOX FRAME/MULLION

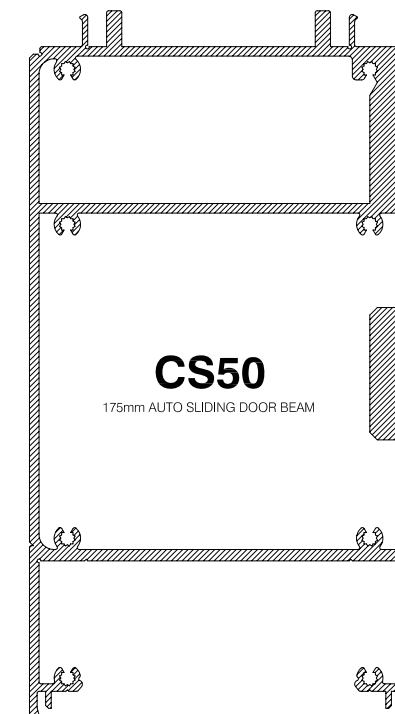

CS50

175mm AUTO SLIDING DOOR BEAM

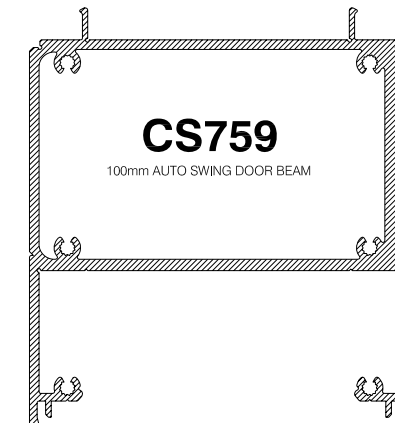

CS759

100mm AUTO SWING DOOR BEAM

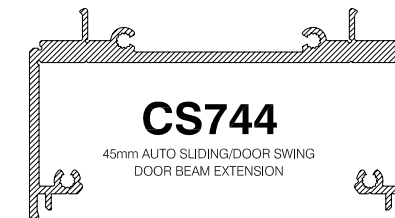

CS744

45mm AUTO SLIDING/DOOR SWING
DOOR BEAM EXTENSION

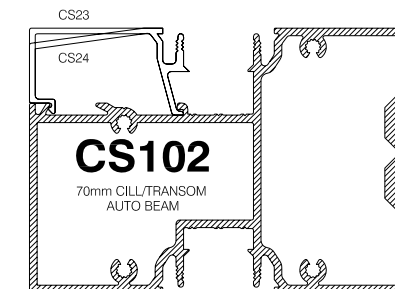

CS102

70mm CILL/TRANSOM
AUTO BEAM

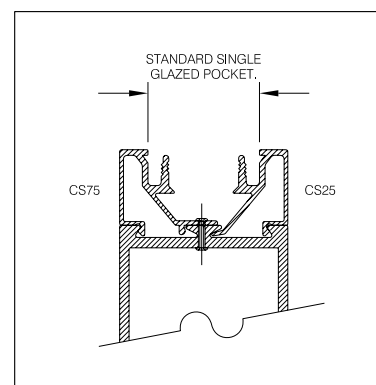

FOR GLASS/BEAD AND GASKET CONFIGURATIONS
SEE GLAZING OPTION (A4 GREEN BORDERED) SHEETS.

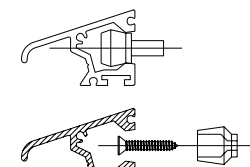

CS83

SCREW OR CLIP FIT DRIP SECTION
FX046SLF STUD & FX045SLF FIXING,
FX047SLF PROFILE RIVET

CS71 FINGER GUARD DOOR FRAME

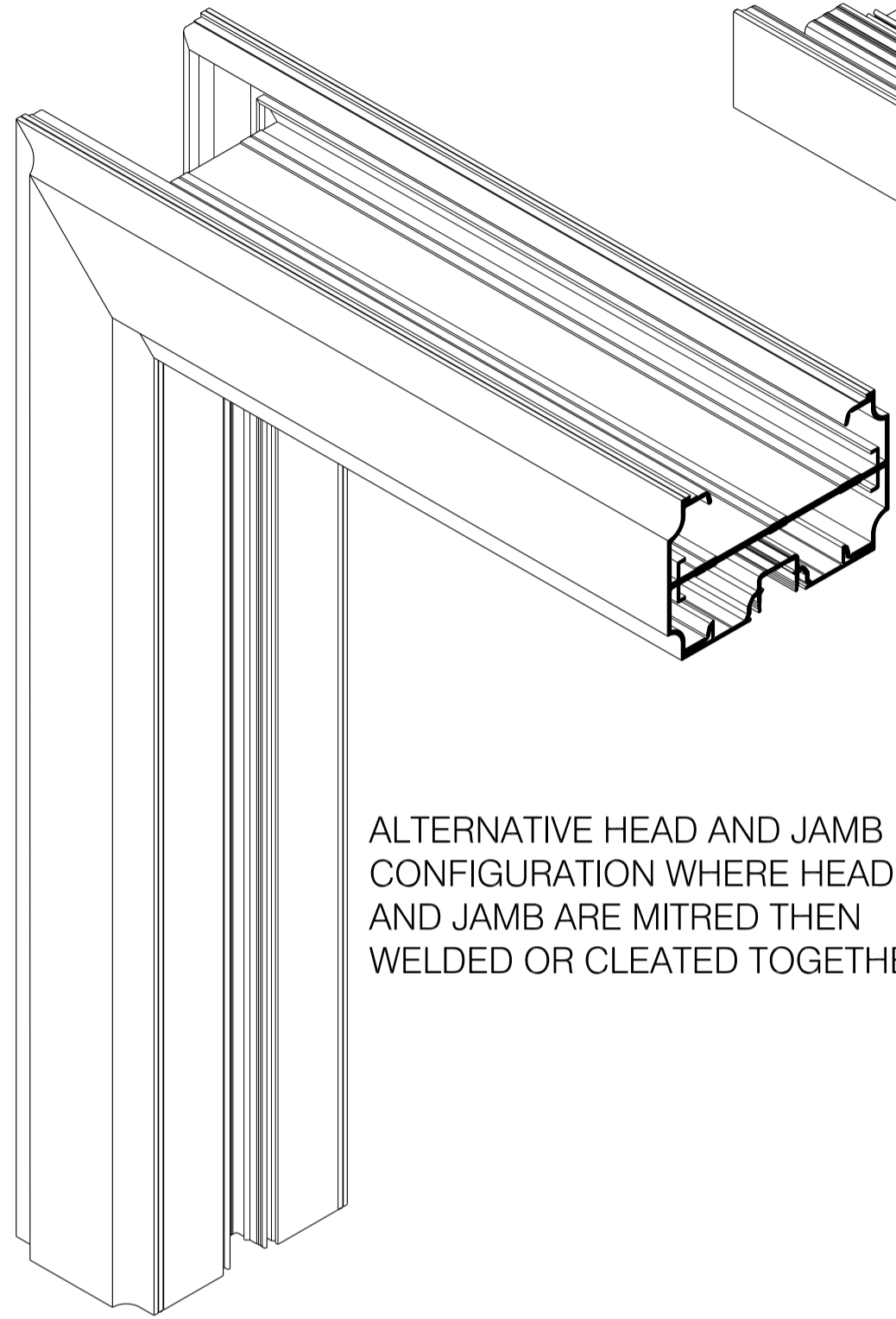

ALTERNATIVE HEAD AND JAMB CONFIGURATION WHERE HEAD AND JAMB ARE MITRED THEN WELDED OR CLEATED TOGETHER.

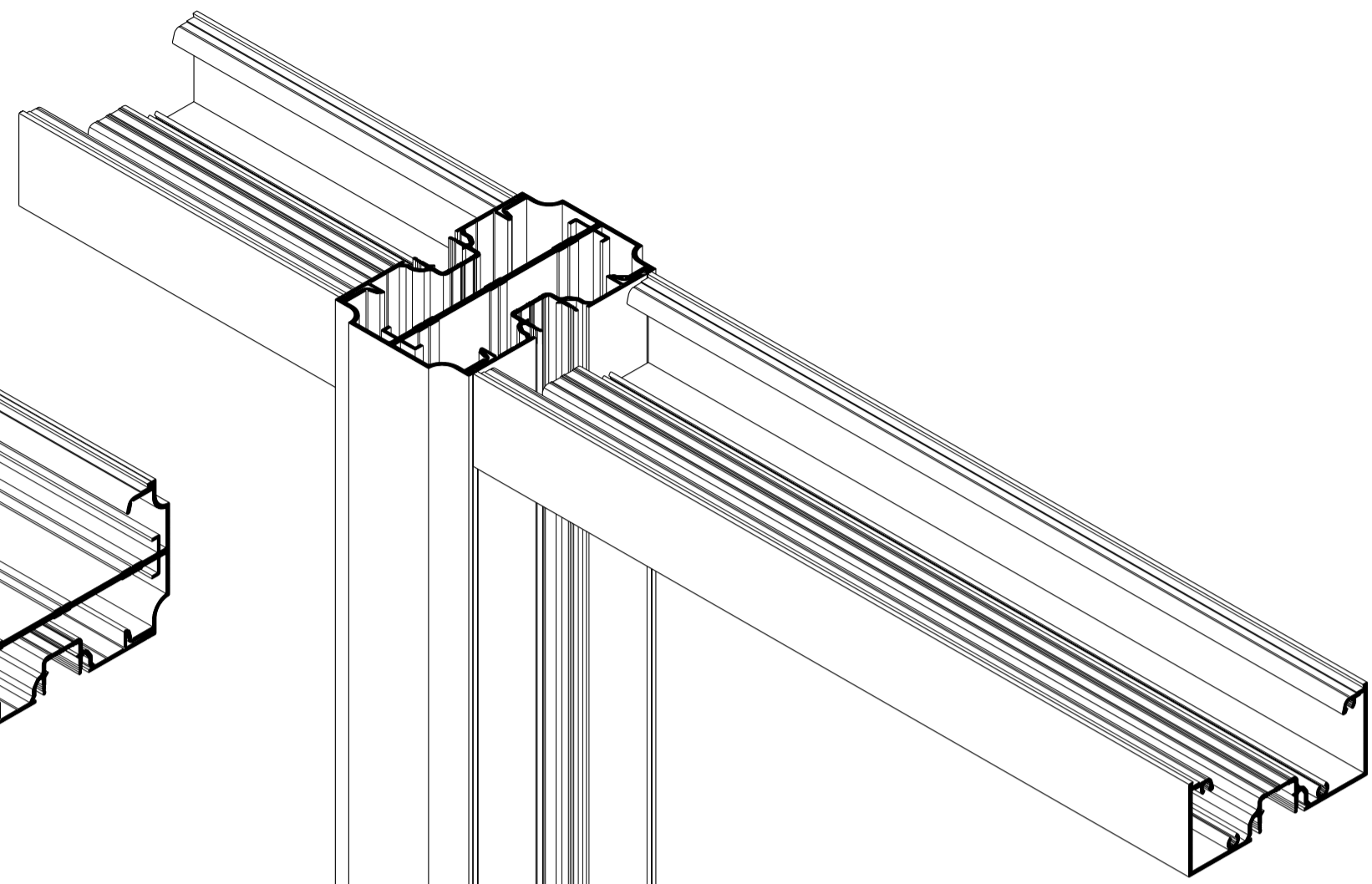

TYPICAL SITUATION SHOWING LIGHT OVER DOOR ENTRANCE WITH SIDE SCREEN.

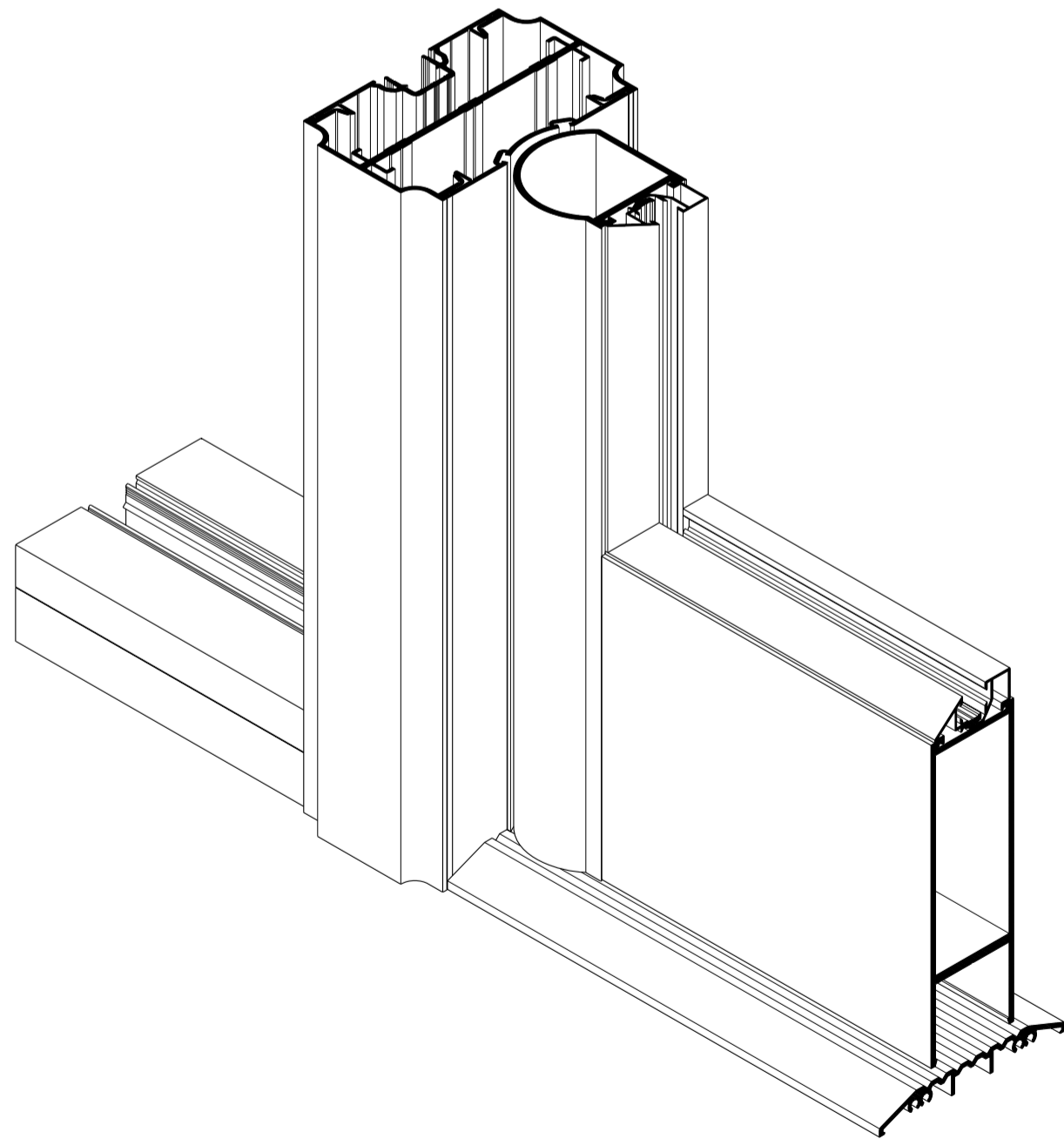

FINGER GUARD DOOR STILE WITH FLAT INTERNAL FACE TO ACCOMMODATE PANIC BAR.

DETAIL OF D/DOORS

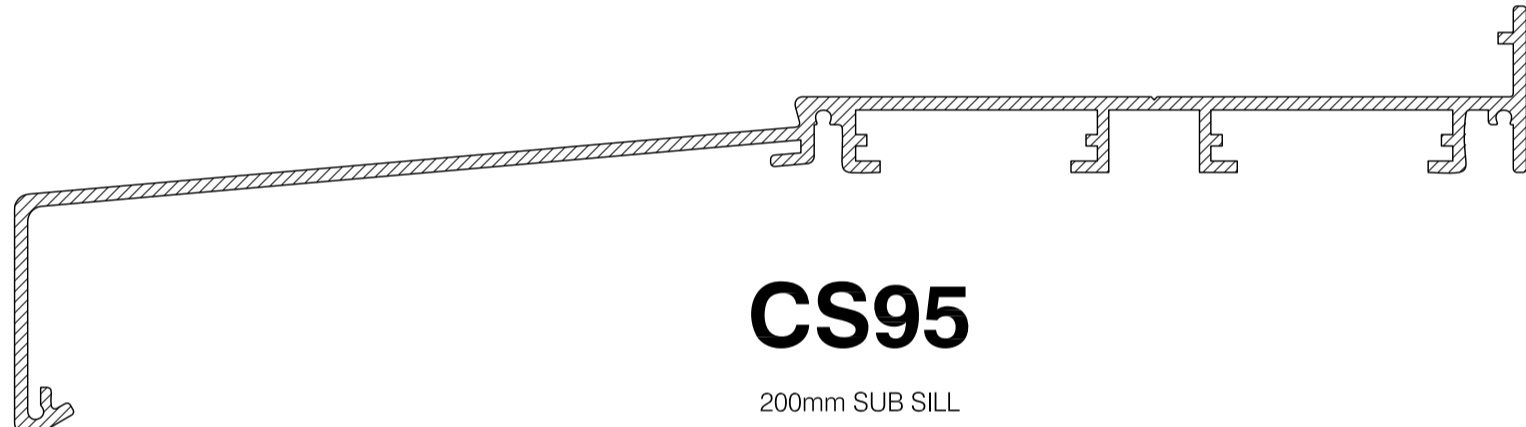
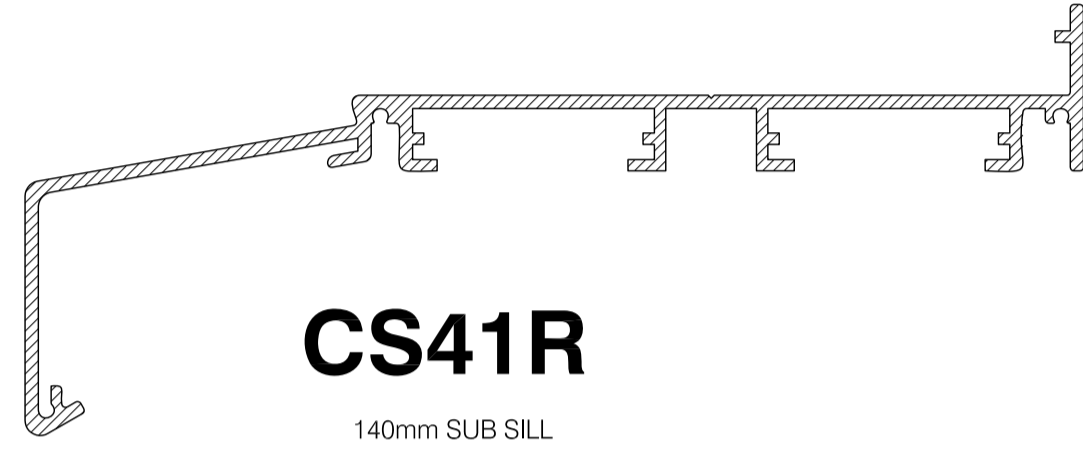
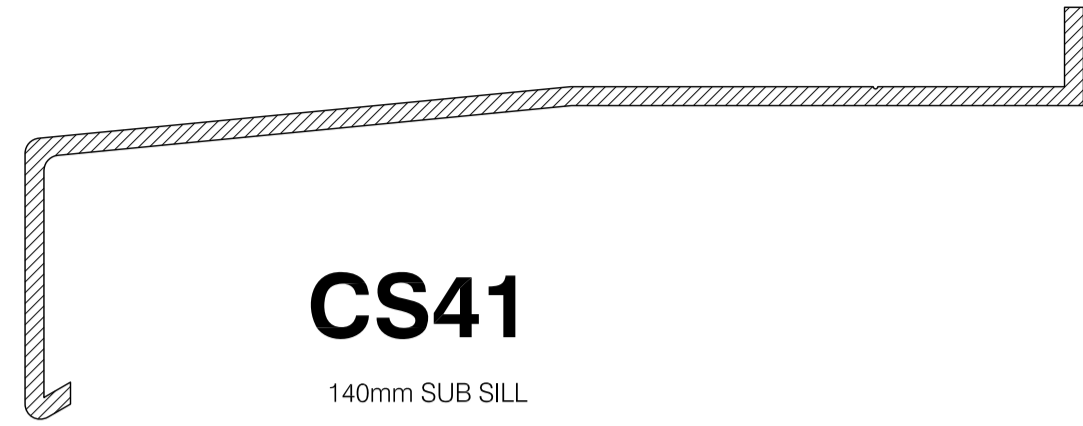
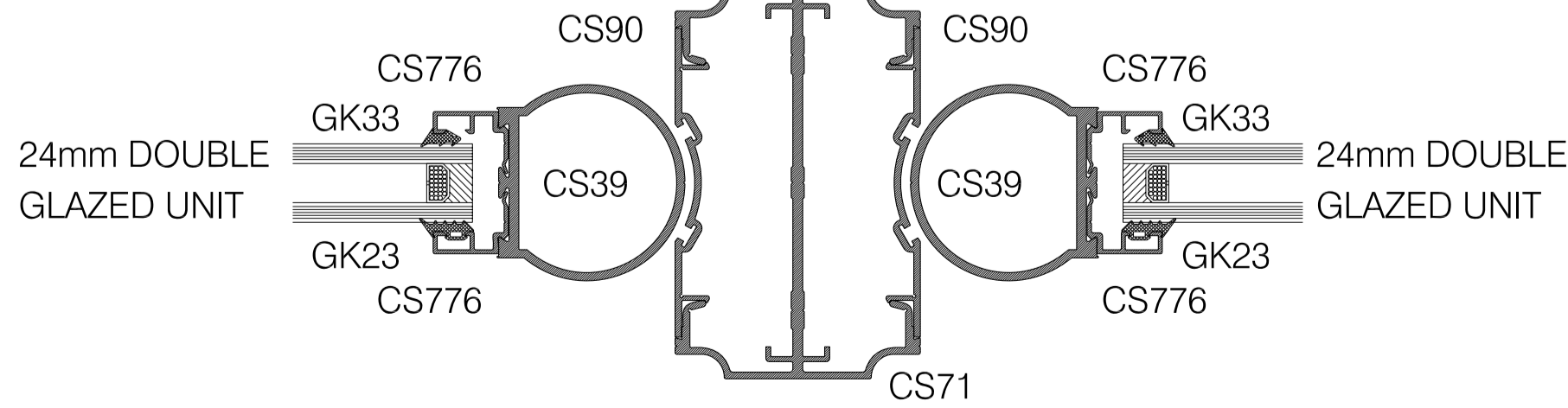

CS585
FRAMEWORK SUB SILL (T.B)

